

REMOTE VIEWING SESSION DATA

 * Remote Viewer : PS 003
 * Interviewer : FA
 * Observer(s) : _____
 * _____
 * _____
 * Date : 10/01/85
 * Starting time : 0905 hours, local
 * Site # : 0762
 * Acquisition by: (CRV) ERV PRV ARV BRV Other _____
 * Working mode : (GT) HEM Other _____
 * Feedback class: A (B) C .
 *

825301
 318317

 * Ending time : 1125 hours, local
 * Notes : Stage VI TMJ
 * Highest stage : VI
 * Evaluation : + 4
 *

 * Actual site : Nazca Lines, Peru
 * RV summary : _____
 * _____
 * _____
 *

Paul
10485
~~total~~
Fr. needs
20755
Fred
0905

825301
318317



A. cross

Confusion break

825301
318317



A. cross
wood
B. land

A. wood
fluis
B. water

A. cross
phit
B. water

S-2
mist
grey
red
metal
hollow sound

Confusion
break

2530L
318317

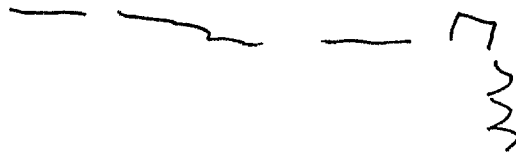

A. K
compression blk
Too much break

82530L
318317



A. above
fluid
B. water
compression break

530L

318317



A. across
road

B. law

A. across
fluid

B. wats

A. up rising
angle across
up angle
across
down

B. structure

S-2

red

rough

grounds

cold

damp

rusty

clammy

humid

fog smell

bank sound

Clang

raised up

angular

solid

A I break

like

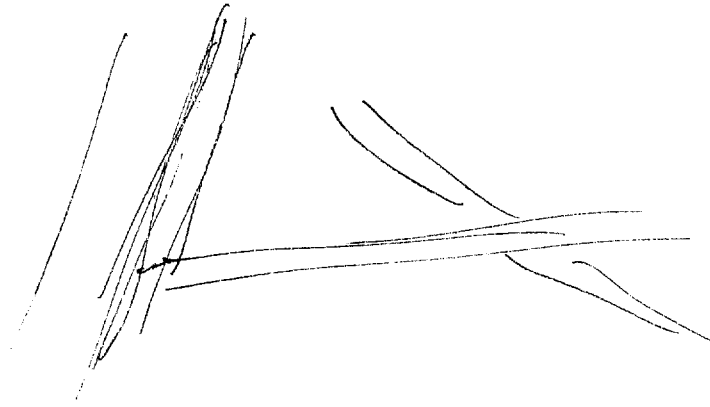

AOL BK
reminded me of
a bridge or
power line
tower

825301

318317



A. Area
land
flat
B. land

A. dropping
compression break

AOL BK
waterfall

AOL BK
hydroelectric
facility

2530L
318317



A. along
land
flat

B. land

A. across
any
down
any
down

B. structure

S-2
white
gray
smooth
rough
brown
echo

AOZ BL
Hoover dam

318317

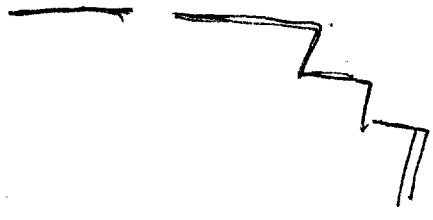

A. across
 bar
 B. land

A. across
 west
 down
 west
 west
 angle
 down
 solid

B. structures

S-2
 bed

A I BK
 Chills

blade
 Grey
 rough
 bumpy
 rounded
 Solid
 levels
 Squat
 rectangular
 wide

AZ BK
sort of interesting

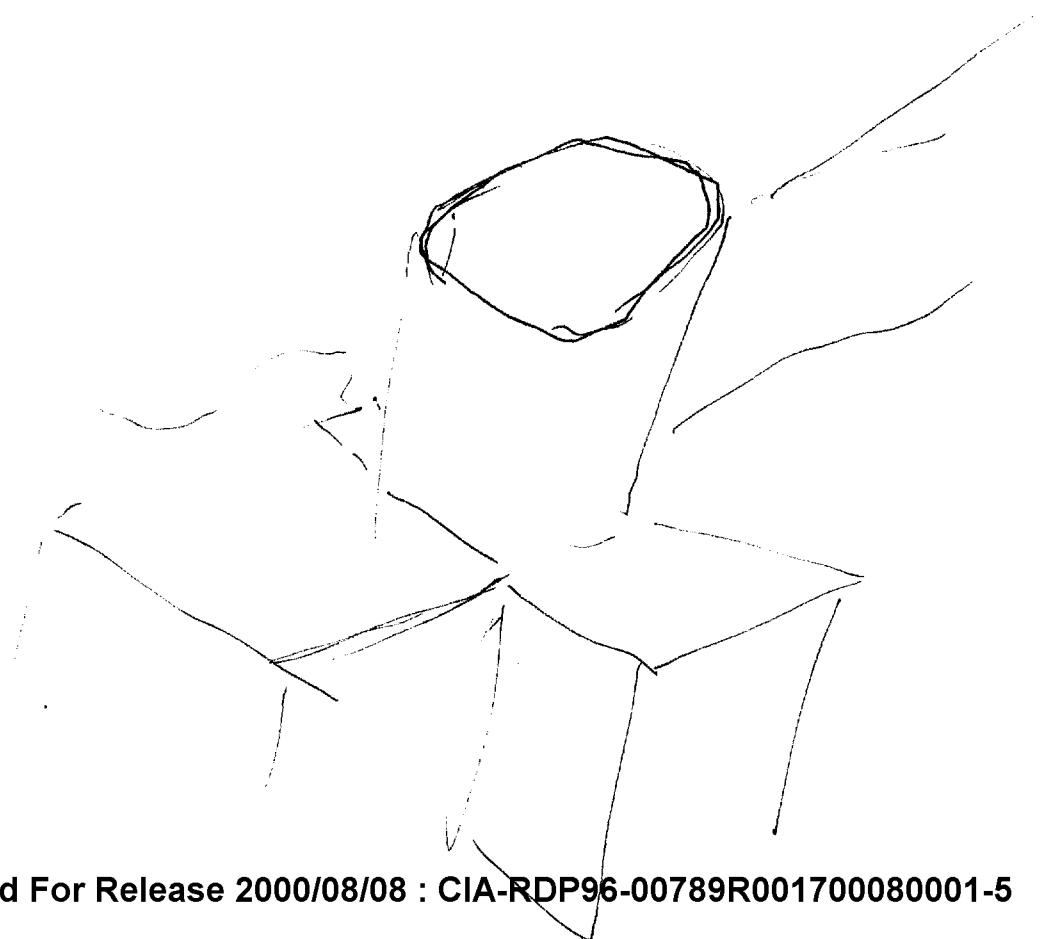
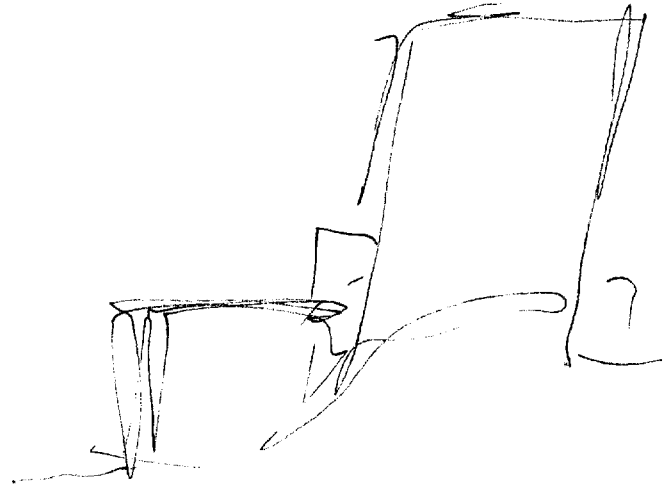

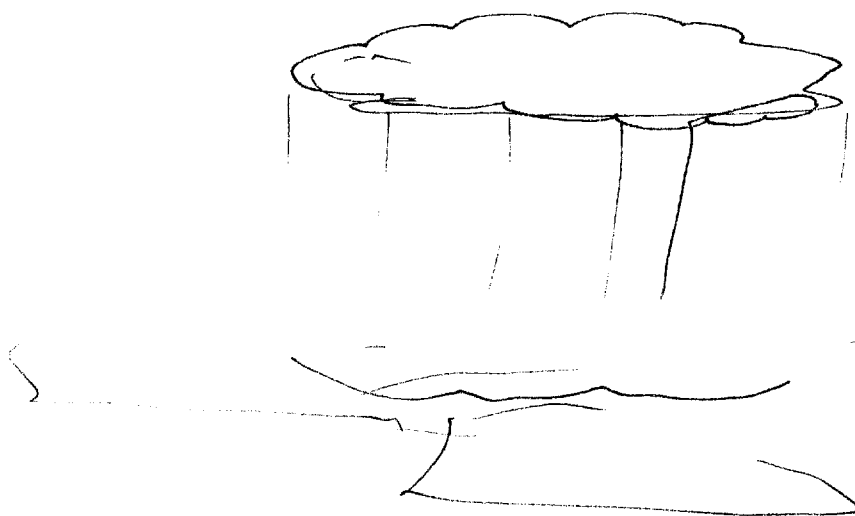
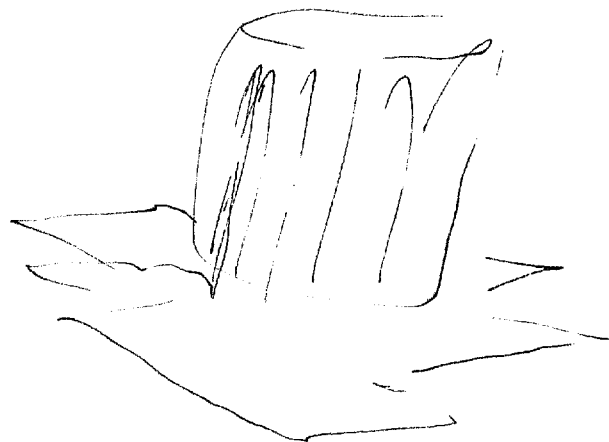

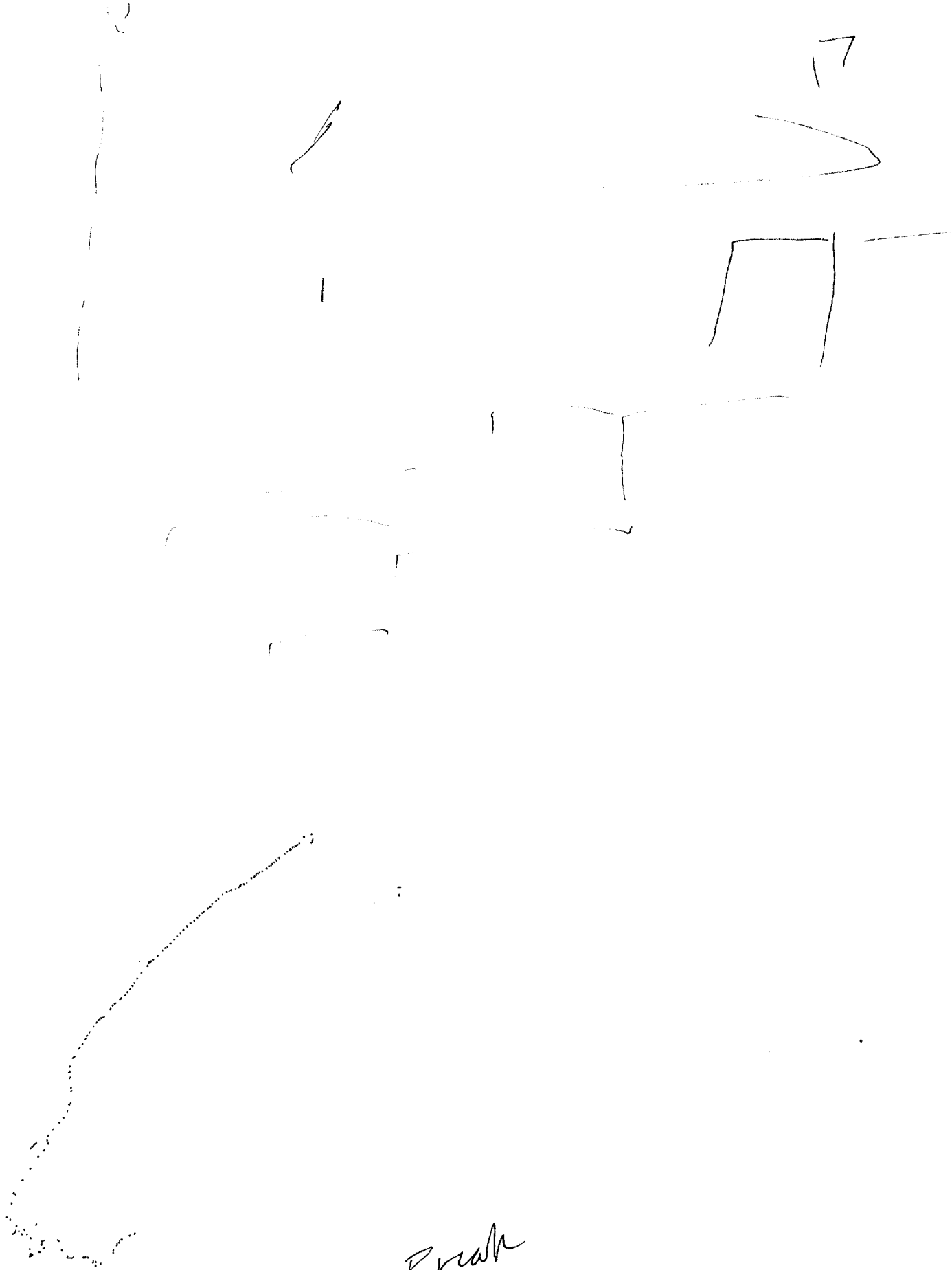

Break

Resume

2530L
318317

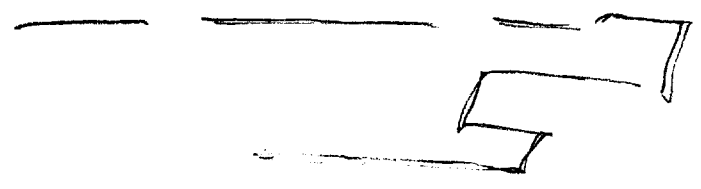

A.
confusion break

82530L
318317

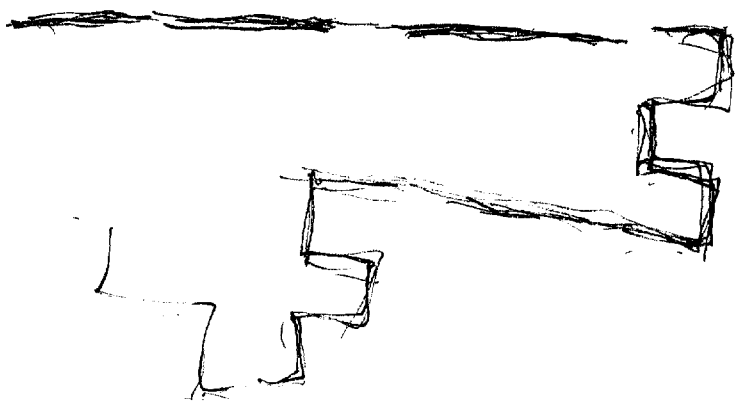

A. across
using
solid
B.

A. along angle
along
solid

B. Structure

A. along
angle

^{Solid}
B. Structure

52

white

green

blue

sandy

rough

stained

pitted

long

low

debris

debris

angles

going along

with

long

than

As Bk
sandy

A2 Bk
Foreseen empty
feeling

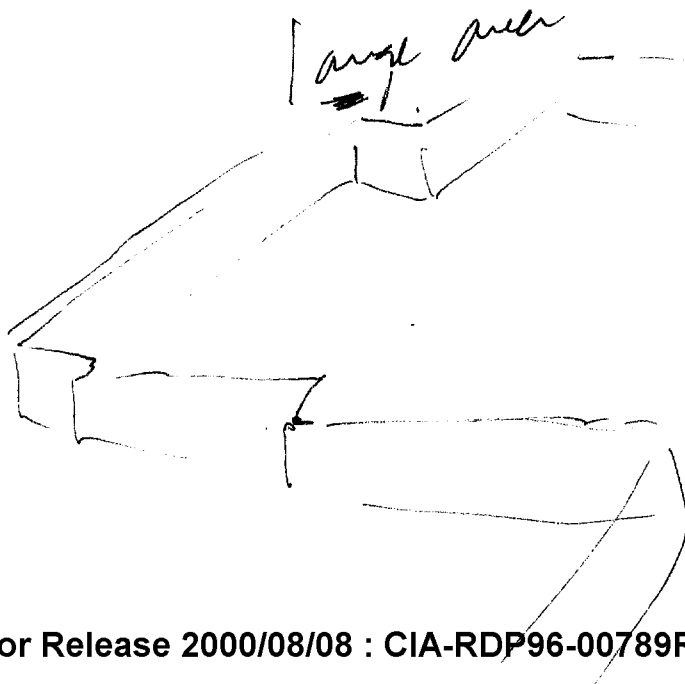

A04 Bk
like a
wall

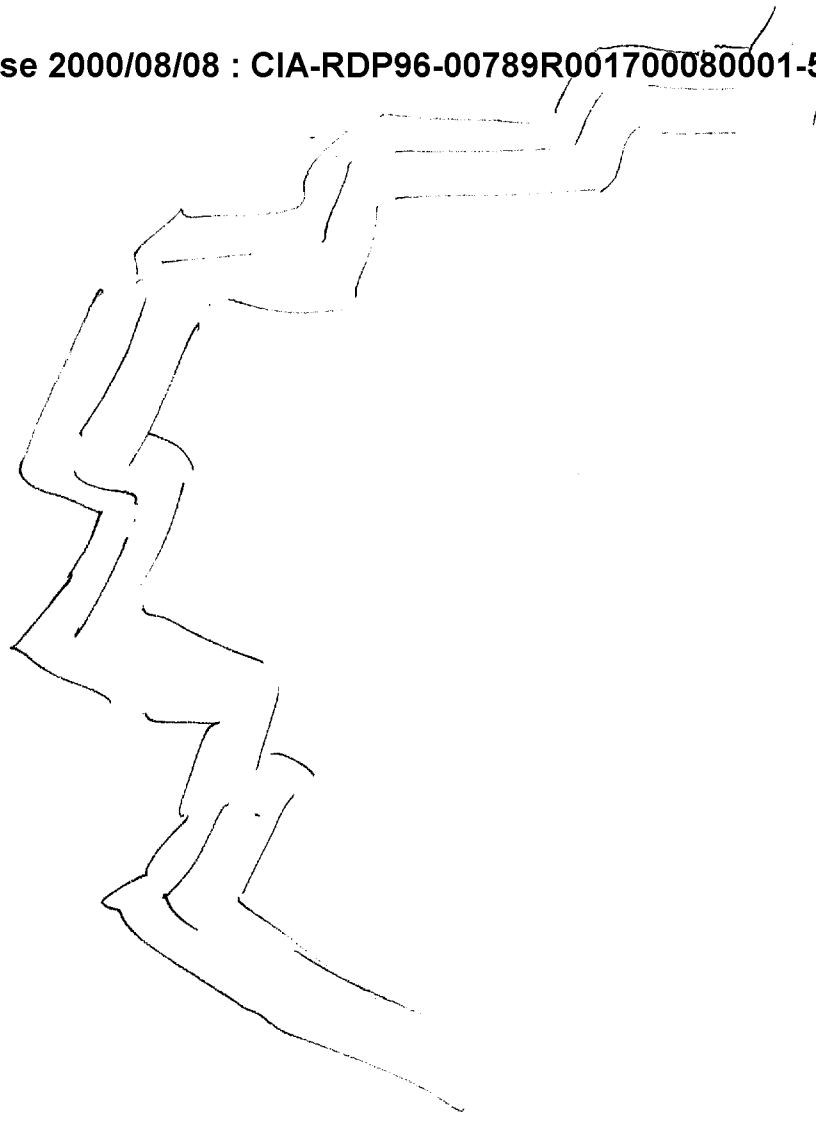

up & down

402 18k

"like
undulating"

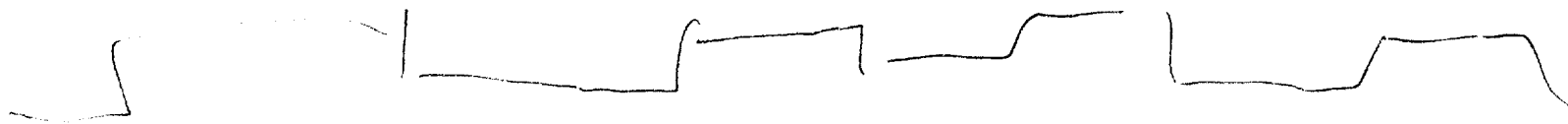



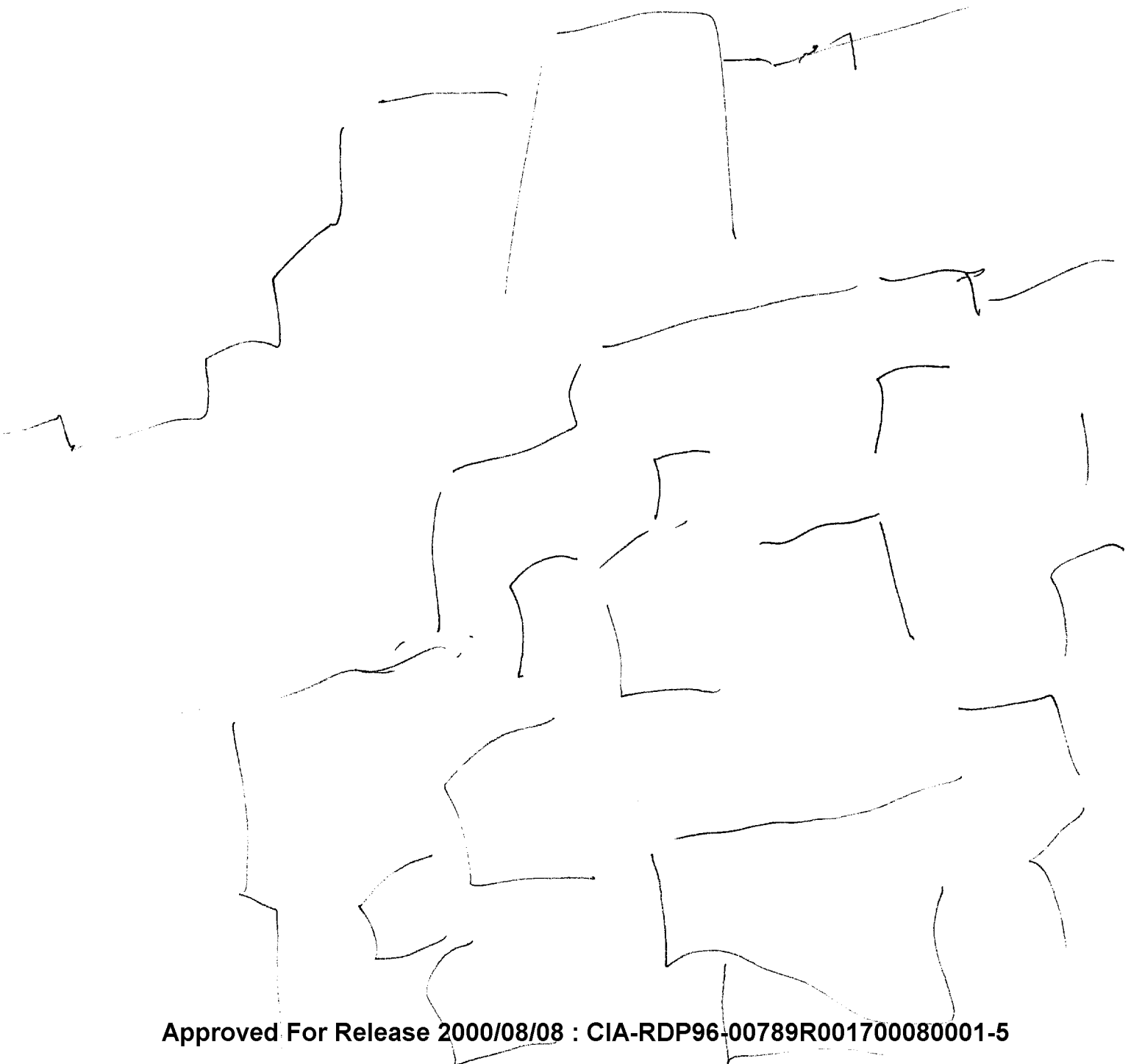

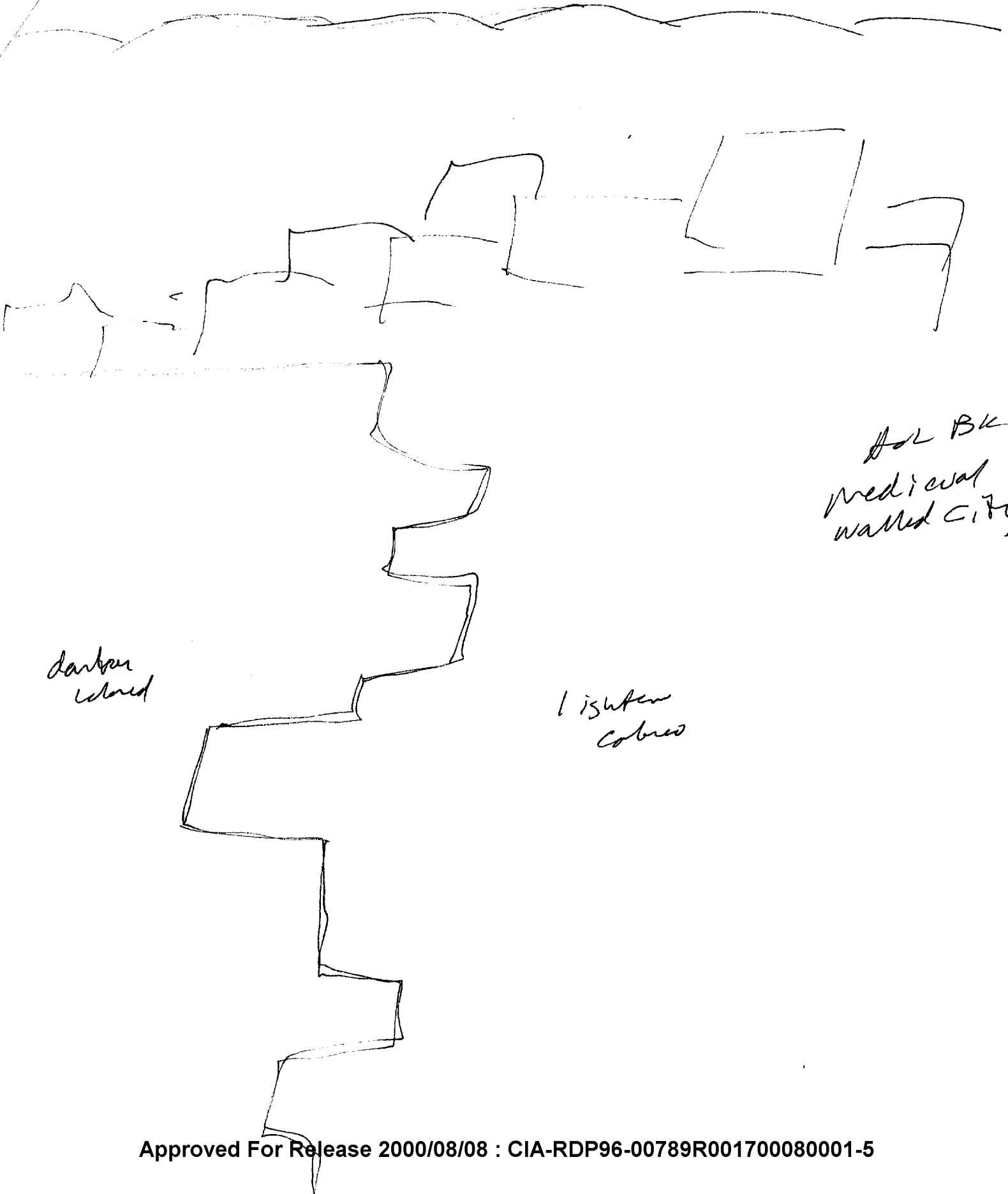

Hol BK
Medical
walled City

dark
colored

lighter
colored

Structures at the site if/are man made, have many 17
high, go for a long distance, and in several different directions
at different times. ~~They are low, patterned, straight, curved~~

Site is somewhat of representational pattern covering a
very broad area; with perhaps symbolic and/or descriptive
purposes; it is made of lines & strips involving very rough,
rough textures. Organization & cooperation were intrinsic in
re construction. Site has a very old, perhaps ancient sense about
it. Structures at site represent animals, birds, & people.
Purposes are apparently affiliated with cosmology, religion, &
mysticism. Construction involved group dynamics & working
together toward a common goal. (A labor of love, not a labor
of force).

Feedback
Nat. Geog. May 1975 716 ff

5-2

D A T E I T I ADL ALS

tapered

long
away
angles

rough
smooth

jointed

menes

up + down

reddish

stepped
spread out

green

structure

horizontal

alcove

carved
colars

umber
ochre

masonry

~ ~ ~ ~

A Z B¹
mystified

ALB
Nazca Lines

no people
present

dark
doorway

inside

Cool
dim

gritty
floor

Chambers

Very
quiet

stale
smell

Outfired
objects
on floor

Stairs

Outside

Sunny

D

AZ

EI

T

I

AOL

A/S

preserved
isolated

Structures

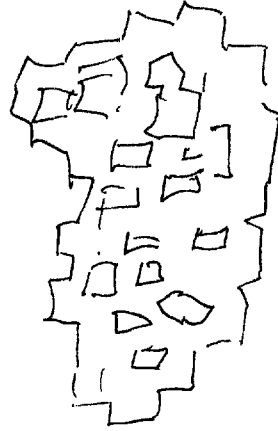

disrepair

weathered

faded
red

Object



2 D AZ EI T I HPL A/S
bound

bound
st. notes

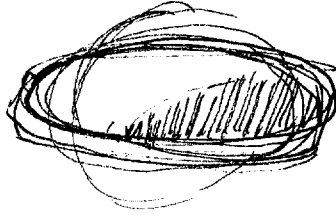

Aoz B k
pueblo
ruins

S VI

2

D

AI

EI

T

I

DOL

Als

PROL Bk
can be seen
vains

PROL Bk
fish farm

~~network~~

network

ruins

rough
bumpy

codes

flat

clattered

pattern

representational

design

path

~~some~~

warmish

bring
of
some sort

form
objects
emanations?
rocks
lines
strips
colors
contrast

Pattern
attributes
emanations?
curved
straight
angular
darkness
lightness
contrast.
flat
low
arranged
large
regular
spread out
natural
Circular

Pattern
Subjects
emanations?
decorative
symbolic
Ancient
monumental

pattern
Topics
evolution?
Cooperation
organization
guidance

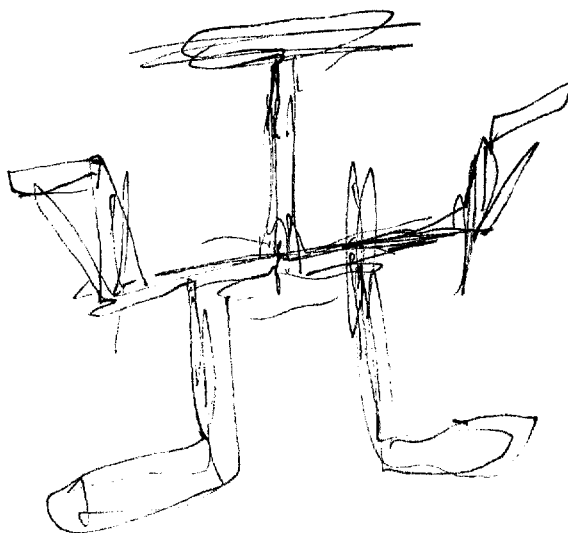
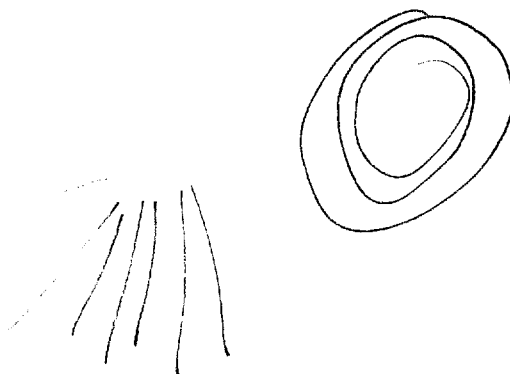

presentational
objects
emanations?

lines
patterns
image

top representation
attributes
emanations?

Representation
attributes
emanations?

Carving
assembled

Representational
subjects
emanations?

animals
birds
people
deities
symbols

Consciousness
Cosmology
Observations
markers

Synapse
Mysticism
Beligion
asceticism
visionary

representational
topics
innovations?
group dynamics
working together toward
a common goal
way marker

End 11:25

Approved

6-00789R001700080001-5

